

MDrive® 17

Step/direction input

with industrial connectors



Specifications

Electrical Specifications	
Input Voltage (+V) Range*	+12 to +48 VDC
Max Power Supply Current (Per MDrive 17)*	2 A

*Actual Power Supply Current will depend on voltage and load.

Environmental Specifications	
Operating Temperature (non-condensing)	Heat Sink: -40°C to +85°C Motor: -40°C to +100°C
Sealing	IP54

Isolated Input Specifications	
Step Clock, Direction and Enable	
Voltage Range (Sinking or Sourcing)	+5 to +24 VDC
Current (+5V Max)	8.7 mA
Current (+24V Max)	14.6 mA

Motion Specifications	
Digital Filter Range	50 nS to 12.9 µS (10 MHz to 38.8 kHz)
Clock Types	Step/Direction, Up/Down, Quadrature
Step Frequency (Max)	5 MHz
Step Frequency Minimum Pulse Width	100 nS
Number of Microstep Resolution Settings	20

Available Microsteps Per Revolution									
200	400	800	1000	1600	2000	3200	5000	6400	10000
12800	20000	25000	25600	40000	50000	51200	36000 ¹	21600 ²	25400 ³

1=0.01 deg/µstep 2=1 arc minute/µstep 3=0.001 mm/µstep

Setup Parameters

Setup Parameters				
Name	Function	Range	Units	Default
MHC	Motor Hold Current	0 to 100	Percent	5
MRC	Motor Run Current	1 to 100	Percent	25
MSEL	Microstep Resolution	See Motion Specifications	µsteps/ Full Step	256
DIR	Motor Direction Override	0/1	—	CW
HCDT	Hold Current Delay Time	0 or 2 - 65535	mSec	500
CLK TYPE	Clock Type	See Motion Specifications	—	Step/ Direction
CLK IOF	Clock Input Filter	50 nS to 12.9 µS (10 MHz to 38.8 kHz)	nS (MHz)	200 nS (2.5MHz)
EN ACT	Enable Active High/Low	High/Low	—	High
USER ID	User ID	3 Characters Viewable ASCII	Viewable ASCII	IMS

Mechanical Specifications

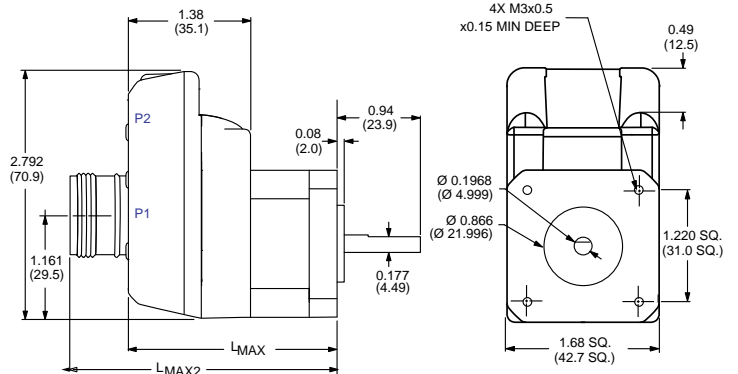

Motor Length	Dimensions in inches (mm)	
	LMAX1	LMAX2
Single	2.48 (63.00)	3.15 (80.00)
Double	2.71 (68.83)	3.38 (85.85)
Triple	3.04 (77.22)	3.71 (94.23)

Notes and Warnings

Installation, configuration and maintenance must be carried out by qualified technicians only. You must have detailed information to be able to carry out this work. This information can be found in the user manuals.

- Unexpected dangers may be encountered when working with this product!
- Incorrect use may destroy this product and connected components!

The user manual is not included, but may be obtained from the Internet at: <http://www.imshome.com/downloads/manuals.html>.

Required for Setup*

- PC running Microsoft® Windows XP Service Pack 2 or greater.
- SPI Motor Interface (available online).
- +12 to +48 VDC unregulated linear or switching power supply.
- 0 to 5 MHz Clock signal for step clock, may be a controller high speed output or signal generator.
- SPST switch or controller I/O point to control axis direction.
- SPI communications interface (recommended: MD-CC301-001 communication converter).

If not using the MD-CC301-001 for interfacing you will need:

- I/O, Power and Communications interface to 19-pin M23 circular connector (recommended: MD-CS100-000 prototype development cordset or equivalent).

* If you purchased your MDrive with a QuickStart Kit, you have received all of the connecting cables needed for initial functional setup and system testing.

Getting Started

All documentation, software and resources are available online at: http://www.imshome.com/products/mdrive_motor_driver.html.

Connecting Power and I/O

Your MDrive is configured with power and I/O combined on a single connector. Please refer to the opposite side of this document for connecting details and available connectivity options.

Connecting Communications

1. Connect USB to SPI communications converter to MDrive and PC.
2. Install the communication converter drivers onto PC (available online).
3. Install and open SPI Motor Interface.
4. Apply power to MDrive.
5. Parameters may be adjusted via two screens, the Motor Settings screen or the I/O Settings screen accessible via the View menu.

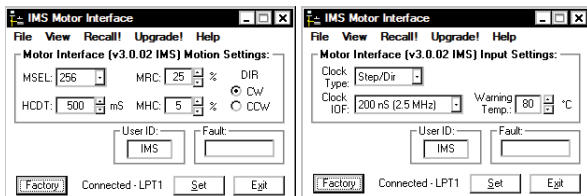

Motor Settings Screen

I/O Settings Screen

MDrive 17 IP65

Step/direction input

Connectivity Options

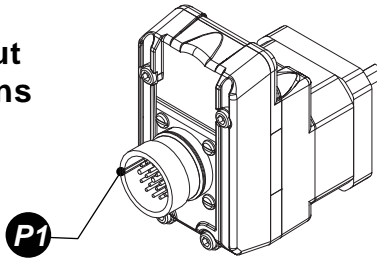

P1 I/O, Power and Communications

M23 industrial connector (male)

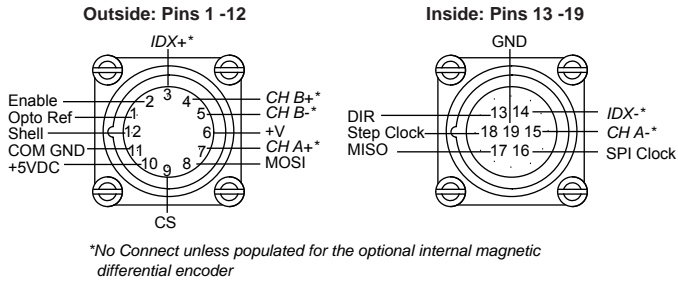

Minimum Required Connections

The diagrams below represent the minimum connections required to operate the MDrive.

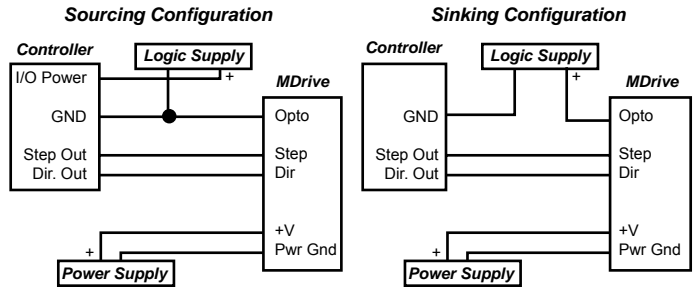

Communications Converter p/n: MD-CC301-001

Electrically isolated in-line USB to SPI converter pre-wired with mating connector to conveniently program and set configuration parameters. A secondary cable from the mating connector provides interface to power and I/O.

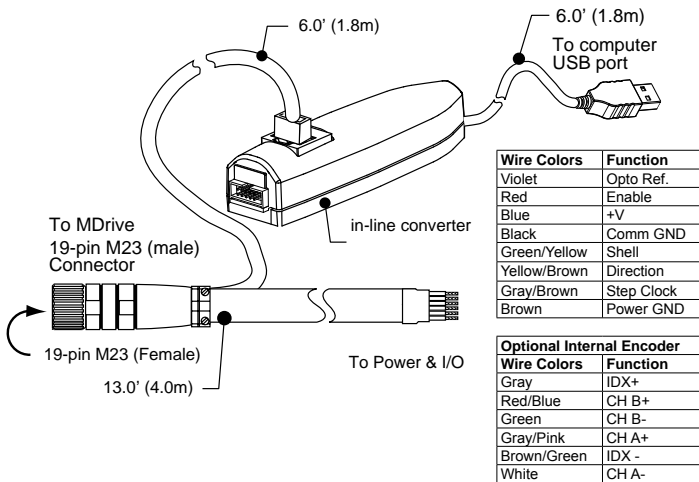

Prototype Development Cordset p/n: MD-CS100/101-000

Speed test and development with pre-wired mating connector.

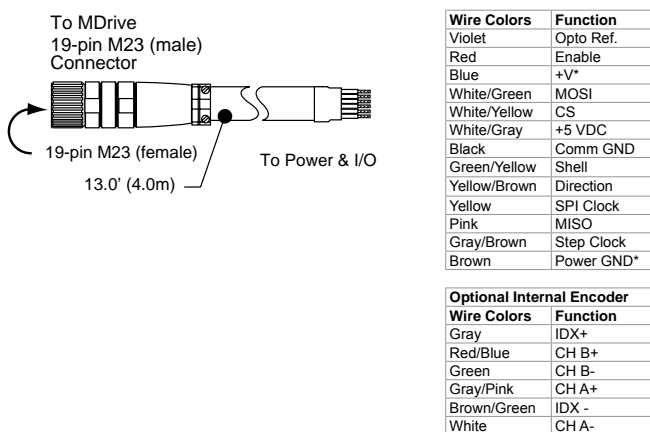

Mating Connector Recommendations

The MD-CS100-000 is recommended with 19-pin M23 connector.

For comparable connector only, shop vendors:

- Lumberg
- Phoenix
- Turck
- RDE Connectors